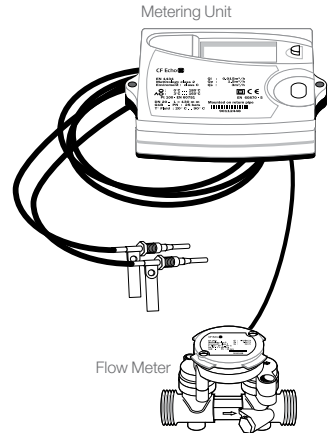

MOUNTING AND OPERATING INSTRUCTIONS**CF Echo II****DELIVERY CF ECHO II**

- Compact heat meter with removable calculator
- 1 connected flow meter
- 2 temperature sensors (optional)
- 1 wall mounting bracket
- 1 package with material for sealing, screws, wall plugs (6 mm)
- 1 set of gaskets

REQUIRED TOOLS

- 3 mm screw driver
- Wrench
- Crosstip screwdriver

**GENERAL INDICATIONS**

Heat meter CF Echo II is a sophisticated electronic measuring instrument. The following instructions must be carefully observed in order to ensure correct mounting and to fulfill all safety and guarantee conditions.

Advice concerning safety

Hot water circuits and mains power supplies run under high temperatures and pressures as well as under high voltages. When operated incorrectly, these may cause serious injuries. Due to this, the measuring units may only be installed by qualified and trained personnel. The casings of the heat meters are designed for cold, warm and hot water with the characteristic values specified for each case, excluding any other liquid. If the integrator casing is submitted to strong shocks, impacts, drops from more than 60 cm height or similar stresses, the heat meter must be replaced. Pipes must be earthed. Before opening the meter, mains voltage (optional) must be isolated.

CE marks and protective classes

Metering unit CF Echo II fulfils the 2014-32-EU (MID) and it's approved according electromagnetic class E1 and mechanical class M1:

- Ambient operation temperature: +5 °C ... +55 °C (indoors installation)
- Storage temperature (without battery): -10 °C ... +60 °C
- Relative atmospheric humidity: < 95 %
- Absolute altitude: < 2.000 m
- Protective class IP 64 according to DIN EN 60529 (protection against dust and splashing); flow meter IP 66/67
- Double protective insulation (protective class II)
- Discarded electronic devices or batteries contained within the CF Echo II must not be put in normal household waste. Dispose in accordance to local government regulations.



Further important instructions

- The flow meter must not be lifted or transported by the connecting cable.
- Mounting position shall be selected so that the connecting cable of the flow meter and the temperature probe cables will not lie near mains cables or other sources of electromagnetic disturbances (minimum distance 50 cm.).
- Cables must not be installed along pipes reaching temperatures above 55 °C.
- Opening of calibration seals will cause the loss of calibration validation and of guarantee, including conformity with pressure equipment directive.
- The casing may only be cleaned on the outside with a soft, damp cloth. Do not use detergents.
- Installation must be carried out according to EN 1434 Part 6.

MOUNTING THE FLOW METER

Operating conditions, dimensions and materials

The operating parameters of the heating circuit must not exceed given values: Nominal pressure 16/25 bars, operating temperature 130 °C, short term maximum temperature 150 °C. For further technical data cf. table:

Thread connection																
Connection	Thread after ISO 228															
Transducer materials	Stainless steel															
O-ring	EPDM															
Pipe materials	brass Cu Zn36 Pb2 AS								bronze Cu Pb5 Sn5 Zn5							
Nominal flow, $q_v (Q_v)$ m ³ /h	0,6		1,5		2,5		3,5		6		10					
Max. flow, q_g m ³ /h	1,2		3		5		7		12		20					
Min. flow, q_l l/h	6		15		25		35		60		100					
Startup flow l/h	1,2		3		5		7		12		20					
Build in length L ₁ , mm	110	130	190	110	130	190	130	190	260	150	260	150	260	260	200	300
Nominal-diameter	15	20	20	15	20	20	20	20	25	25	25	25	25	32	40	40
Thread connection G	¾"B		1"B		¾"B		1"B		1"B		1¼"B		1¼"B		2"B	
Hight A ₁ , mm	72	72	72	72	72	72	72	72	77	77	77	77	77	77	85	85
Hight A ₂ , mm	110	110	110	110	110	110	110	110	114	114	114	114	114	114	123	123
Hight A ₃ , mm	18	18	18	18	18	18	18	18	23	23	23	23	23	23	35	35
Weight, kg	1,1	1,2	1,5	1,1	1,2	1,5	1,1	1,4	1,9	1,5	1,9	2,4	2	1,8	2,5	5,5
Internal diameter d _i , mm	19	19	19	19	19	19	29	29	28,5	28,5	28,5	28,5	28,5	28,5	44	44
Pressure loss at q_v , bar	0,04	0,04	0,04	0,22	0,22	0,22	0,17	0,17	0,17	0,11	0,11	0,13	0,13	0,13	0,09	0,09

Flange connection

Connection Flanged after EN1092, PN 25

Transducer materials Stainless steel

O-ring EPDM

Pipe materials	brass Cu Zn36 Pb2 AS				bronze Cu Pb5 Sn5 Zn5								
	Nominal flow, q_v (Q_v), m ³ /h	0,6	1,5	2,5	3,5	6	10	15					
Max. flow, q_m m ³ /h	1,2	3	5	7	12	20	30						
Min. flow, q l/h	6	15	25	35	60	100	150						
Startup flow l/h	1,2	3	5	7	12	20	30						
Build in length L ₁ , mm	190	190	190	260	300	260	300	270	250	300	270	250	270
Nominal diameter	20	20	20	25	40	25	40	50	40	40	50	50	50
High A, mm	72	72	72	77	77	77	77	85	77	77	85	85	85
High A ₁ , mm	110	110	110	114	114	114	114	123	114	114	123	123	123
High A ₂ , mm	52,5	52,5	52,5	57,5	75	57,5	75	82,5	75	75	82,5	82,5	82,5
Weight movable flanges, kg (former version)	3,2	3,2	3,2	4,5	7,1	4,5	5,8	8,6	8,2	8	9	9	8,8
Weight mobile flanges, kg (new version)	-	-	-	3,6	5,4	3,7	5,5	6,4	6,5	6,2	7	7	6,5
Flange Diameter D, mm	105	105	105	115	150	115	150	165	150	150	165	165	165
Bolt circle diameter K, mm	75	75	75	85	110	85	110	125	110	110	125	125	125
Bolt holes diameter L, mm	14	14	14	14	18	14	18	18	18	18	18	18	18
Number of holes	4	4	4	4	4	4	4	4	4	4	4	4	4
Flange dimension F, mm	100	100	100	110	140	110	140	160	140	140	160	160	160
Internal diameter d _i , mm	19	19	20	28,5	28,5	28,5	28,5	28,5	44	44	44	44	44
Pressure loss at q_{p1} , bar	0,03	0,21	0,15	0,12	0,12	0,13	0,13	0,13	0,08	0,08	0,08	0,20	0,20

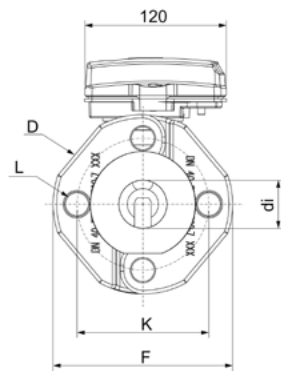
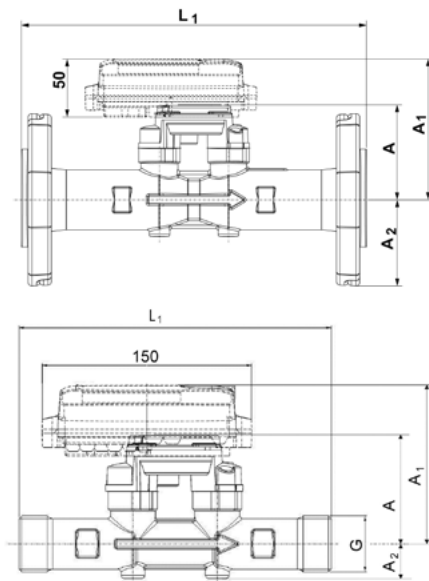

MOUNTING INSTRUCTIONS

- Never carry out welding or drilling work near the meter.
- Leave the meter in its original package until all connections, insulating, painting and cleaning tasks have been performed.
- Always install the meter according to the mounting position indicated on the nameplate (supply or return).
- The flow meter may be installed either horizontally or vertically, but not upside down.
- The heat meter must be protected against shocks and vibrations which might occur at the place of installation. When charging the pipes with water, isolation valves must be opened slowly.
- Thread and flange connections of the meter must match with the nominal width DN and nominal pressure PN (according to EN 1092) of the corresponding counterparts of the pipes. The metering unit must not be subject to excessive tensions caused by pipes or molded parts. The pipes of the heating system must be secularly fastened before and after the flow meter. In case of flange connections, all bolts must be used and tightened. All bolts, nuts and gaskets used must comply with the nominal width DN, the pressure level PN, the maximum admissible temperature and pressure.

INSTALLATION ISOLATION

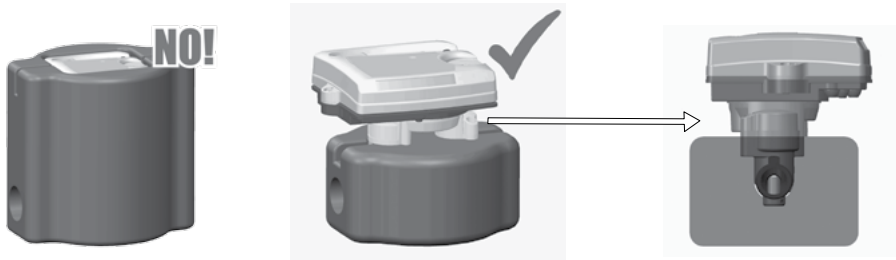

Attention:

Do not cover plastic parts of the meter with isolating material.

GENERAL INSTALLATION SCHEMATIC

CF Echo II DN ≤ 20

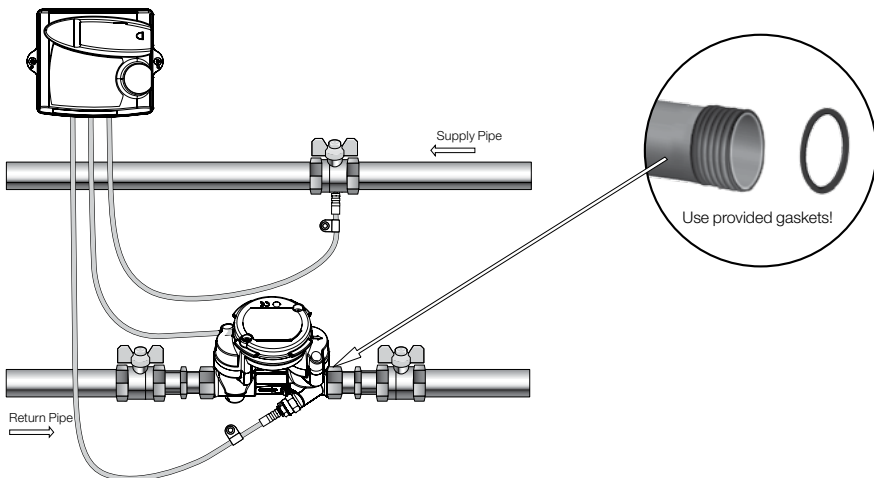

Installation CF Echo II DN ≥ 25

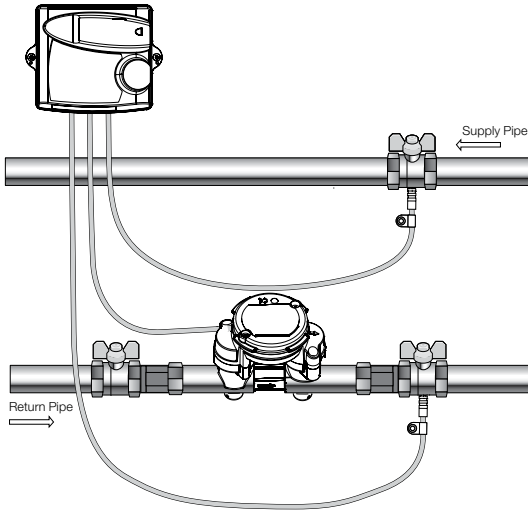

Attention:

Please let water drop down from cable connections and avoid waterflow in direction of integrator/flow meter. Take special attention in cooling systems due to condensating water.

POSITION OF THE FLOW SENSOR

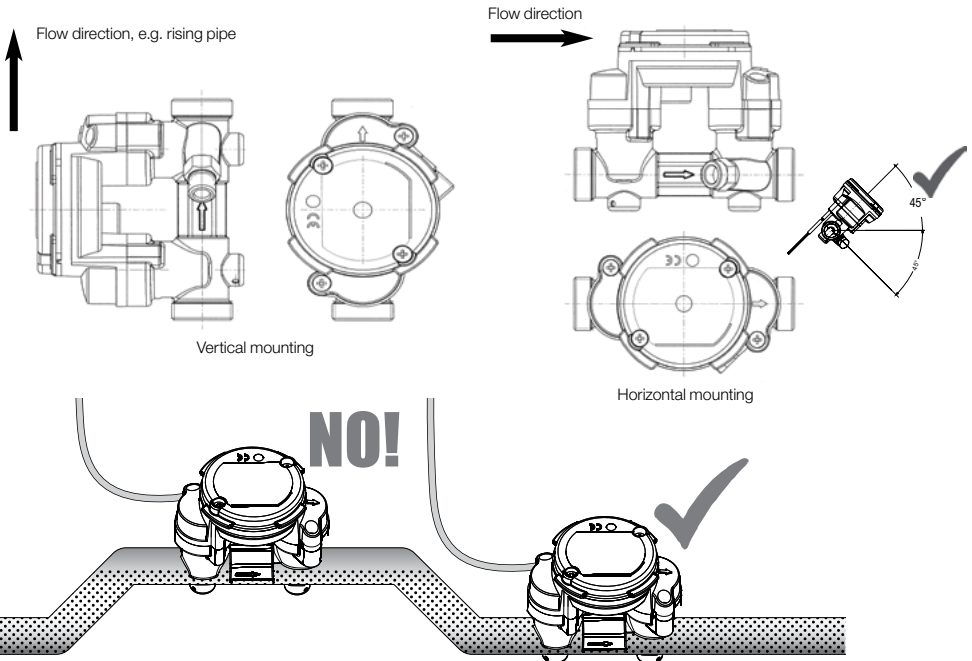

Attention:

The flow meter must always be completely filled with liquid! Flow meter must not be installed at the highest point of an installation to avoid air inside the meter.

MOUNTING OF METER WITH MOBILE FLANGES (NEW VERSION)

1.

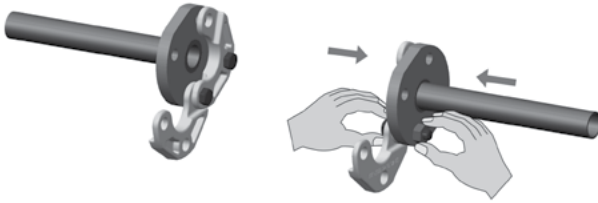

- Put any two mobile flange segments together and screw them by hand onto the two button holes of the pipe.
- Leave the mobile flanges open.

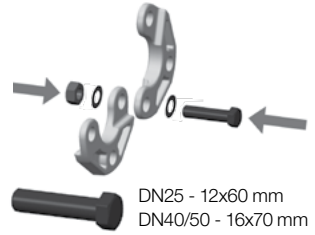

DN25 - 12x60 mm
DN40/50 - 16x70 mm

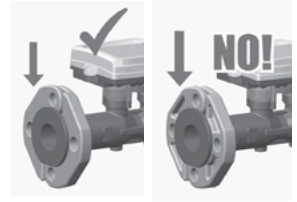

Attention:

Smooth side of flange outwards.

2.

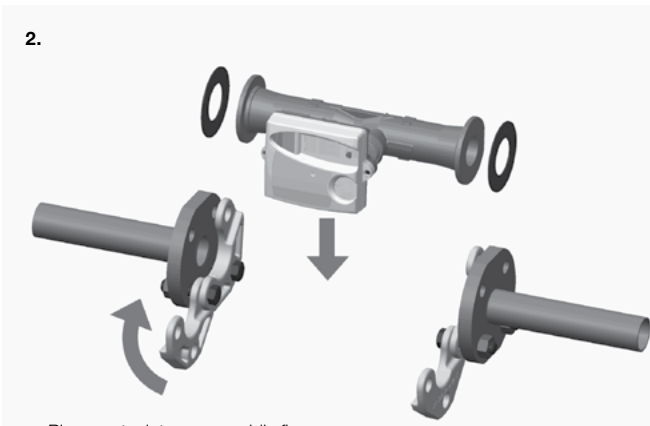

- Place meter into open mobile flanges
Attention: Use provided gaskets!
- Close mobile flanges

OPTION: METER WITH MOVABLE FLANGES (FORMER VERSION)

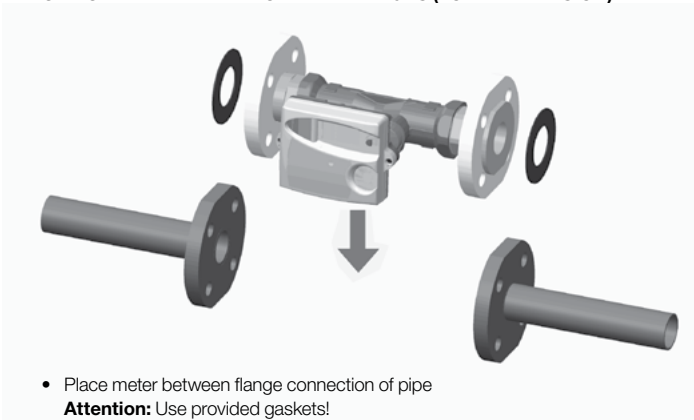

- Place meter between flange connection of pipe
Attention: Use provided gaskets!

3.

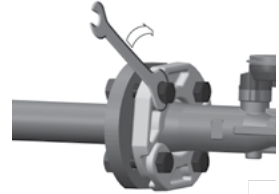
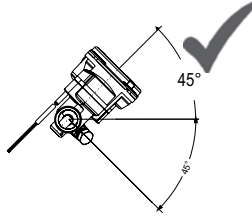
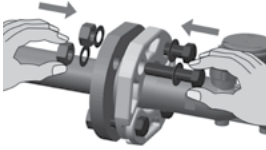
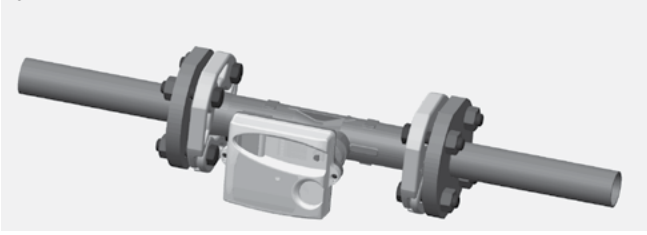

- Insert remaining screws and screw them first by hand
- Align flow meter into correct position
- Tighten all screws with a tool/spanner

MOUNTING OF THE INTEGRATOR

Mounting of the integrator

The integrator must not be installed with the flow meter when environmental temperature is permanently above 55 °C or in case of operation for cooling purposes.

Set metering unit with an angle of 45° on the support

Rotate metering unit 45° till it engages.

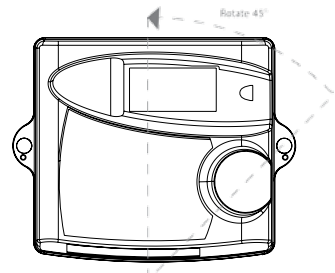
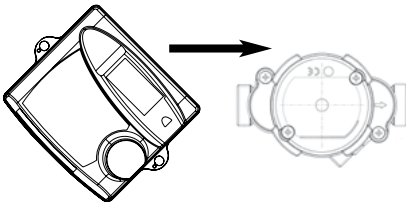

Mounting on the wall

If temperatures in the heating circuit are permanently higher than 90 °C, or if ambient temperature is more than 55 °C, it is recommended to mount the integrator on the wall.

Screw the supplied wall support to the wall or fasten it to a cool pipe.

Set the integrator with an angle of 45° on the support Rotate the metering unit by 45° till it engages.

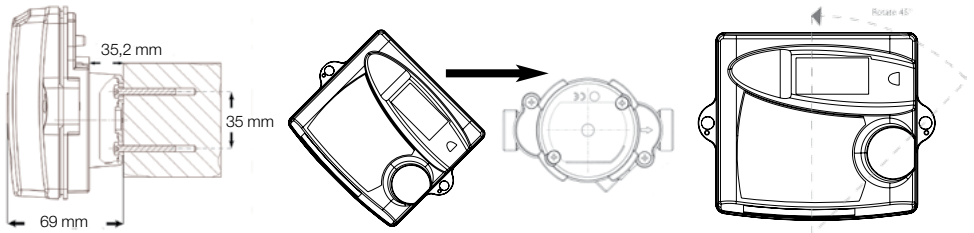

MOUNTING OF TEMPERATURE PROBES

Technical data

- | | |
|------------------------|--|
| • Connection | 2 wire technology |
| • Cable diameter | 3.5 mm ... 6.5 mm |
| • Maximum wire section | 0.2 ... 1.5 mm ² |
| • Type | PT 100 or PT 500 according to DIN EN 60751
(Observe nominal value of integrator – see sensor nameplate) |

Mounting

- Only use pairs of temperature probes with the same serial number. Probe cable must not be shortened or lengthened.
- One temperature sensor should be installed near to the outlet of the flow meter. Flow meters DN15 and DN20 offer a measuring point directly integrated in the flow meter (see details below).
- Both supply and return temperature sensors should be installed in a similar way to ensure symmetric measurement and therefore best accuracy. Don't mix direct installation and installation in pockets.
- When laying the cables, a minimum distance of 50 mm to main power cables and/or sources of electromagnetic interferences should be respected.
- In case of strong sources for electromagnetic disturbances (e.g. high power machines and pumps, frequency and power converters, power switches, neo tubes) it's recommended to increase the minimum distance to meter signal cables to 50 cm.

Probes must be mounted according to the guidelines of EN 1434.

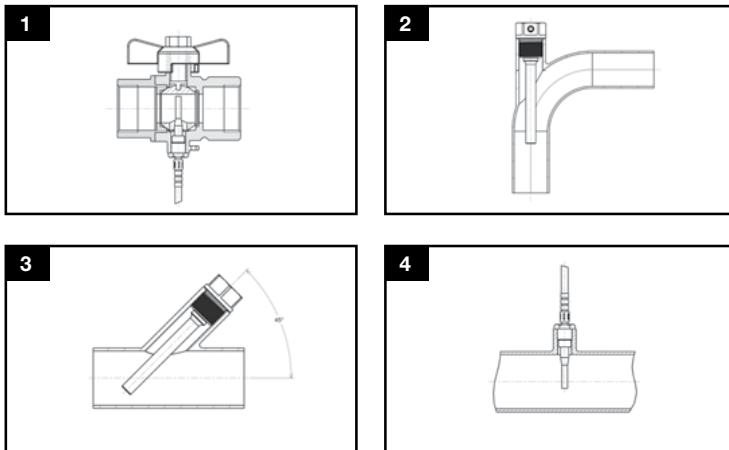

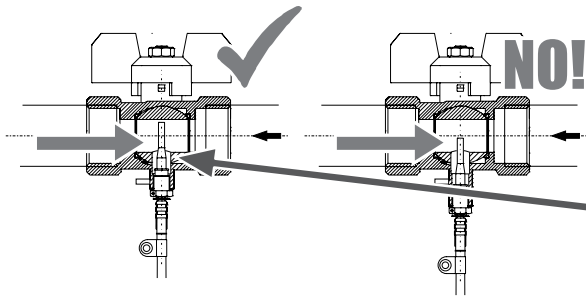

Attention:

To achieve highest accuracy, the tip of the probes/pockets should reach the center of the pipe.

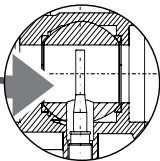

MOUNTING OF TEMPERATURE PROBE INTO FLOW METER (IF NOT ALREADY DONE IN FACTORY)

For normal flows Q_p 0,6 - 2,5, the return measuring point for direct measuring probes of type DS or for pocket type probes PS must be integrated in the flow meter.

DS, measurement in flow meter
(DN 15/20 only)

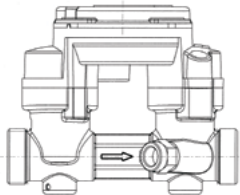
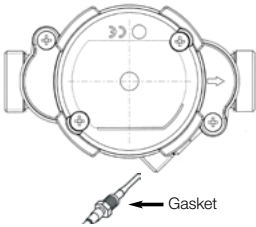

PS, measurement in flow meter
(DN 15/20 only)

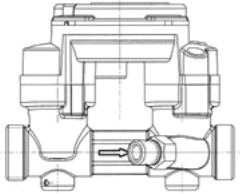
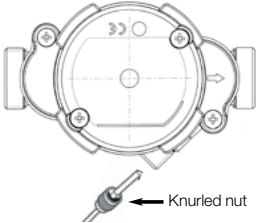

TEMPERATURE PROBES

Connection of temperature probes

Please note the following instructions to connect temperature probes in heating-, cooling or combined heating-cooling systems:

Warm connector



Cold connector



Heating system	supply probe	return probe
Cooling system	return probe	supply probe
Combined heating-cooling system	supply probe	return probe

- Pierce cable glands ① and ② of the calculator
- Pull the supply temperature probe cable (= warmer line) through cable gland ① and the return probe cable (= colder line) through cable gland ②.
- Make a loop to resist tension and loop over the corresponding support (cf. figure).
- Connect wires according to the plan of terminal connections.

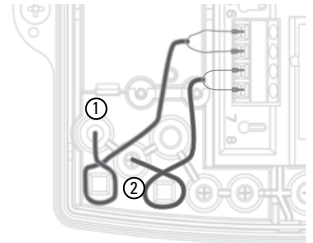

Plan of terminal connections

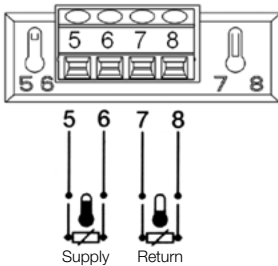
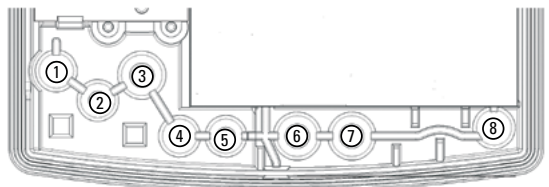

Fig.: Probe connection with 2 wire technology

Cable glands:

1. $\varnothing 4.25 \pm 0.75$ mm2 – T. probe (supply)
2. $\varnothing 4.25 \pm 0.75$ mm2 – T. probe (return)
3. $\varnothing 6 \pm 1$ mm2 – mains power supply – optional
4. $\varnothing 4.25 \pm 0.75$ mm2 – optional
5. $\varnothing 4.25 \pm 0.75$ mm2 – optional
6. $\varnothing 6 \pm 1$ mm2 – T. probe (supply)/optional
7. $\varnothing 6 \pm 1$ mm2 – T. probe (return)/optional
8. $\varnothing 3.75 \pm 0.75$ mm2 – flow meter



POWER SUPPLY

Three types of power supply are available. As standard, system is fitted with a 6 years battery.

Battery for 6 years*

Type 2 x lithium 3,6 V-AA, soldered to an insert board

Use only original battery. Do not recharge, open, heat to more than 100 °C, expose to an open flame or immerse in water. Do not dispose through domestic waste. Dispose in accordance to local government regulations.

- Connect battery using plug-in connectors.
- Place the battery into the corresponding recess in the integrator casing and engage.

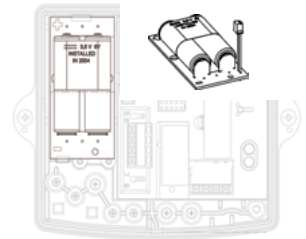

Lithium 3,6 V-AA



CAUTION: Leave the calculator with change from battery to main operation and turned around 5 minutes without voltage supply. Afterwards check the internal clock and if necessary reset it.

* Optional: 12 years battery available on request.



CAUTION: Risk of explosion if battery is replaced by an incorrect type. Dispose of used batteries in accordance to local government regulations.

Mains module

- | | |
|-----------------------------|-----------------------------|
| • Mains voltage | 230 V ± 15 % |
| • Mains frequency | 50 Hz ± 2 % |
| • Maximum power requirement | 1 VA |
| • Type of cable | 2 wires (no earth) |
| • Cable diameter | 4.5 mm ... 7.0 mm |
| • Section of wire | 0.5 ... 2.5 mm ² |

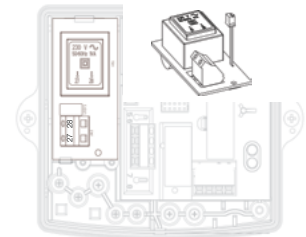

Mains module

Heat meters with mains power supply must be connected according to installation instructions. The mains power supply must be protected against voltage failures. Protective systems (circuit breakers) must be used, in order to ensure secure disconnection of the unit from the mains in case of electric trouble (breaking current < 1A).

An emergency circuit breaker should be:

- installed within reach
- clearly recognizable as an emergency breaker
- cut off both wires
- clearly show the on/off position

The connecting cable of the mains option must be directly connected to the breaker switch.

- Cut off grid voltage (breaker switch).
- Open meter casing and connect the mains power supply using the plug.
- Introduce the mains option board into the corresponding recess in the casing.
- Pierce the third cable gland from the right and pull through mains cable.
- Clamp the cable using the tension relieving system.
- Connect wires to terminals No. 27 and 28 (safe guard against wrong polarity, strip 8 mm of insulation).
- Close casing lid and switch on mains voltage.

Start up

- Check all functions, especially the correct display of temperatures and volume flow.
If the casing was opened:
 - > replace upper part of casing and screw together
 - > secure screws with users seal (use supplied plastic seals or wire seals).

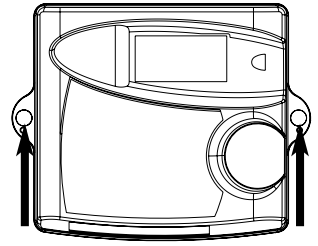

OPERATING INSTRUCTION CF ECHO II

A heat meter is a measuring instrument used to measure the energy released in a heating or cooling system. A compact heat meter consists of the partial components formed by the pair of temperature probes, the flow meter and the integrator, the complete instrument in itself being subject to compulsory calibration when in commercial utilization. The meter collects the measuring values of the pair of probes and of the flow meter, permitting the display of diverse data over 3 separate display levels.

- Display level 1: billing level (cumulated energy and volume display)
Display level 2: service level (actual operating data of the heat meter)
Display level 3: due date level (13/24* months values for cumulated energy and volume)



* Software version 20-47 and higher















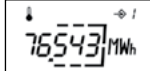

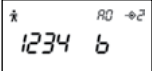
LC display and signification of segments

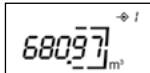
1. Alarm symbol: energy measurement stopped for cause of trouble
2. Dirt alarm: energy measurement continued, cleaning of the flow sensors are necessary
3. Temperatures: appears for temperature related displays or for displays of cooling energy in case of combined heating/cooling meters.
4. Flow display: permanent symbol: flow is present / flashing symbol: no flow
5. Date & time: representation of date and time indications related to time dependent displays, e.g. due day values and maximum values.
6. Display level: actually selected display level
7. Unit: physical unit
8. Decimal point
9. Pulse weight of exterior connected water meters (only when a corresponding option board is being used)
10. Maximum value: appears when maximum values are displayed
11. Operating time: appears for operating time display
12. Not used
13. Water meter 1 or 2: display concerns exterior water meter (1 or 2)
14. Main display area: 7 digits for the display of all values displaying all cumulated and actual values

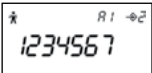
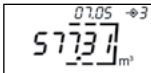
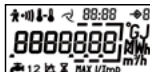
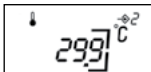

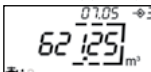
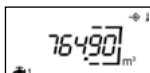
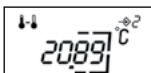
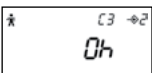
All display levels and displays in detail

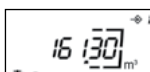
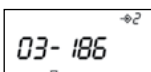
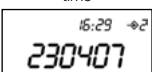
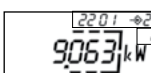
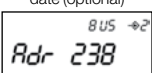
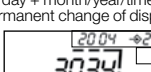
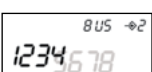
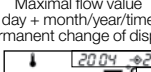
Depending on the type of unit, the actual range of display may differ from the one shown here. Pressing of the push button activates the LC display. Switching of levels is achieved by pressing for 2 sec. of push button , change of display through short pressing of push button 

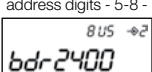
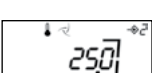
 755 13 MWh Energy (MWh, kWh or GJ)	 1389 m ³ /h Flow	 382h Failure hours	 07.05 +3 680 76 MWh Due day values energy, month 1...13/24*
 76543 MWh Cooling energy (MWh, GJ or kWh) - optional	 9083 kW Power	 1234 b Error code temperature measurement	 07.05 +3 70 135 MWh Due day values cooling energy, month 1...13/24* (optional)
 68097 m ³ Volume	 1500 °C Supply temperature	 1234567 Error code flow measurement	 07.05 +3 5773 m ³ Due day values volume, month 1...13/24* (optional)
 8888888 MWh LCD-Test	 299 °C Return temperature	 290h Overload times	 07.05 +3 62 125 m ³ Due day values water meter ½ month 1...13/24* (optional)
 76490 m ³ Water meter 1 -optional	 2089 °C Temperature difference	 0h Mains voltage failure time	 So Fct +3 19-38 Software version
 16 130 m ³ Water meter 2 -optional	 03-186 Operating time	 16:29 +2 230407 Integrator time and date (optional)	
	 22 01 +2 9063 kW MAX Maximum power display day + month/year/time permanent change of display	 8 U5 +2 Adr 238 MBus primary address	
	 20 04 +2 3034 m ³ /h MAX Maximal flow value day + month/year/time permanent change of display	 8 U5 +2 1234 678 MBus secondary address	
	 20 04 +2 1500 °C MAX Maximum temperature day + month/year/time permanent change of display	 8 U5 +2 123 5678 MBus secondary address digits - 5-8 -	
		 8 U5 +2 bdr 2400 MBus baudrate	
		 250 Utmp Pulse weight water meter ½ (optional)	

* Software version 20-47 and higher

INDICATIONS CONCERNING SPECIAL DISPLAY FUNCTIONS (partly optional, depending on type of unit)

Energy and volume index (display levels 1 and 3)

The energy unit is programmed at the factory. As a standard, energy is displayed in MWh, optionally kWh or GJ are possible.

Cooling energy (display level 1)

Display of cumulated cooling energy for energy versions for utilization as combined heating/cooling circuits (please refer to point 9 for more detailed information).

Water meters 1 and 2 (display level 1)

Display of the meter status of connected supplementary water meters with impulse output, using a corresponding optional board (please refer to point 8 for more detailed information).

Maximum value display (display level 2)

The actual monthly maximum values for power output, flow and flow temperature are displayed with the corresponding time stamp. Internally, 13/24* monthly maximum values are stored for each case, which may be read out via the M Bus or the optical interface. The duration of period to assess the maximum values is 60 minutes. The duration of period may be varied via the M Bus or the optical interface within a range of 1 min – 1440 min (= 1 day).

* Software version 20-47 and higher

Operating trouble alarm (display level 2)

In case of operating trouble, CF Echo II displays a symbol "  ". When this trouble alarm appears, maintenance should be called. CF Echo II shows detailed information concerning operating troubles in special display levels (cf. description of display).

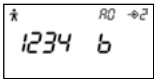

Display level operation shut down code

A0 = trouble with temperature recording

- 1 = supply temperature probe is not connected, pipe is interrupted or broken
 - 2 = return temperature probe is not connected, pipe is interrupted or broken
 - 3 = negative temperature difference; temperature probes were exchanged (except in case of combined heating/cooling metering)
 - 4 = Analog to digital converter is broken (instrument must be replaced)
- b = low battery voltage (replace battery)*

* Software version 20-47 and higher

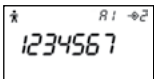

Display level operation shut down code (optional)

A1 = trouble with flow measurement

- 1 = backflow in meter or in pipe system
- 2 = air in the pipe system, broken ultrasound probes or very strong deposits on the probes (cleaning or inspection required)
- 3 = exceeding the maximum admissible flow
* this message is a warning and does not cause measurement shut down.
- 4 = connection cable with flow transponder or connection to the ultrasound probes has been disconnected.
- 5 = no flow for > 24 hours, but $\Delta T > 15$ K
- 6 = no data communication between integrator and flow meter
- 7 = problem with the option board

M Bus parameters (display level 2)

Representation of characteristic data for remote data readout over M Bus or optical interface.

Due day values (display level 3)

Representation of 13/24* end of the month values of the cumulated values for energy, volume, cooling energy (optional) and volume of the connected water meters, with time stamp and beginning with the value of the previous month.

* Software version 20-47 and higher

INSERT OPTION BOARDS

The function range of the integrator may be extended for data communication and data remote display by means of inserting different option boards. The following option boards are available:

- M Bus + 2 exterior water meters
- M Bus + 2 exterior water meters power supply by M Bus
- M Bus + E/V Repetition
- LON + 2 exterior water meters
- RF (AnyQuest / EverBlu) – (Main power supplied products)
- RF (AnyQuest / EverBlu) + 2 exterior water meters (Battery power supplied products)
- GPRS + E/V Repetition + M Bus Master

Details concerning mounting and start up are described in the mounting and operating instructions of the corresponding option boards.

SPECIAL VERSION FOR USE IN COOLING AND COMBINED HEATING/COOLING CIRCUITS

Meter for utilization in cooling circuits

For these types of products, the heat meter unit has been especially identified and programmed at the factory for utilization in cooling systems.

Handling, LC display and utilization of the option boards is essentially in accordance with the heat meter unit, all energy and power output related display values, M Bus data and remote display impulses being related to cooling energy.

The integrator is programmed for installation of the flow meter in the “warm” pipe of the cooling system (= return of the cooling system). A version programmed for the installation of the flow meter in the cold pipe also is available as an option.

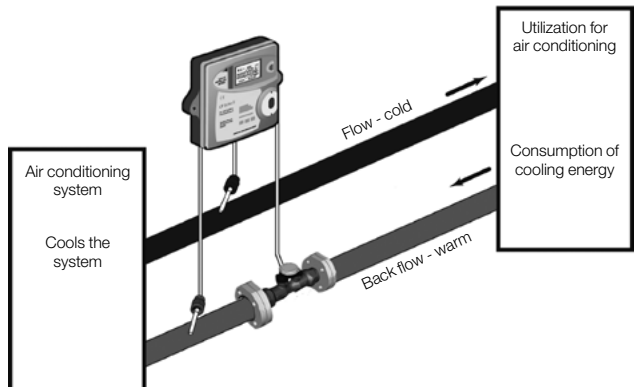

Integrator for utilization in combined heating/cooling circuits

For these product versions, the integrator has been identified and programmed at the factory especially for utilization in air conditioning systems with combined heating and cooling operation.

Handling, LC display and utilization of the option boards is essentially in accordance with the heat meter. The following special characteristics must be taken into account:

Boundary conditions for the metering of heating and cooling energy

- Heating energy is measured as soon as the temperature difference ΔT exceeds 0.5 K and supply temperature T_s exceeds 25 °C ($\Delta T = \text{supply temperature } T_s - \text{return temperature } T_r$).
- Cooling energy is measured as soon as the temperature difference ΔT remains below -0.5 K and supply temperature is less than 25 °C. A version with switched off T_s threshold is available as option*.

LC display

- Display of cooling energy is carried out in a supplementary register in the 1st display level. In order to differentiate from heating energy, a thermometer symbol being displayed simultaneously.
- 13/24* due day values (end-of-the-month values) for cooling energy may be called up in the 3rd display level.

Option boards for remote display

- The option board outputs are marked "E" (for energy) and "V" (for volume). For this type of product, pulses proportional to the cooling energy are output at the cooling energy output marked "V".

This type of product is programmed for installation of the flow meter in the return pipe of the air conditioning system (= cold pipe during operation as heating, warm pipe during operation for cooling). A version programmed for the installation of the flow meter in the supply pipe also is available as an option.

* Software version 20-47 and higher

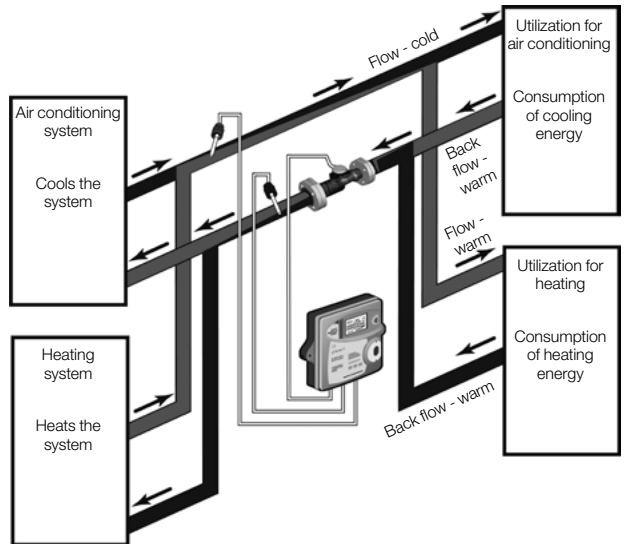

Itron is a global technology company. We build solutions that help utilities measure, manage and analyze energy and water. Our broad product portfolio includes electricity, gas, water and thermal energy measurement and control technology; communications systems; software; and professional services. With thousands of employees supporting nearly 8,000 utilities in more than 100 countries, Itron empowers utilities to responsibly and efficiently manage energy and water resources. Join us in creating a more resourceful world; start here: www.itron.com.

ALLMESS GMBH
Am Voßberg 11
23758 Oldenburg i.H.
Germany

Tel: +49 (0) 43 61/62 5-0
Fax: +49 (0) 43 61/62 5-250
www.itron.com